

**Harmony™**

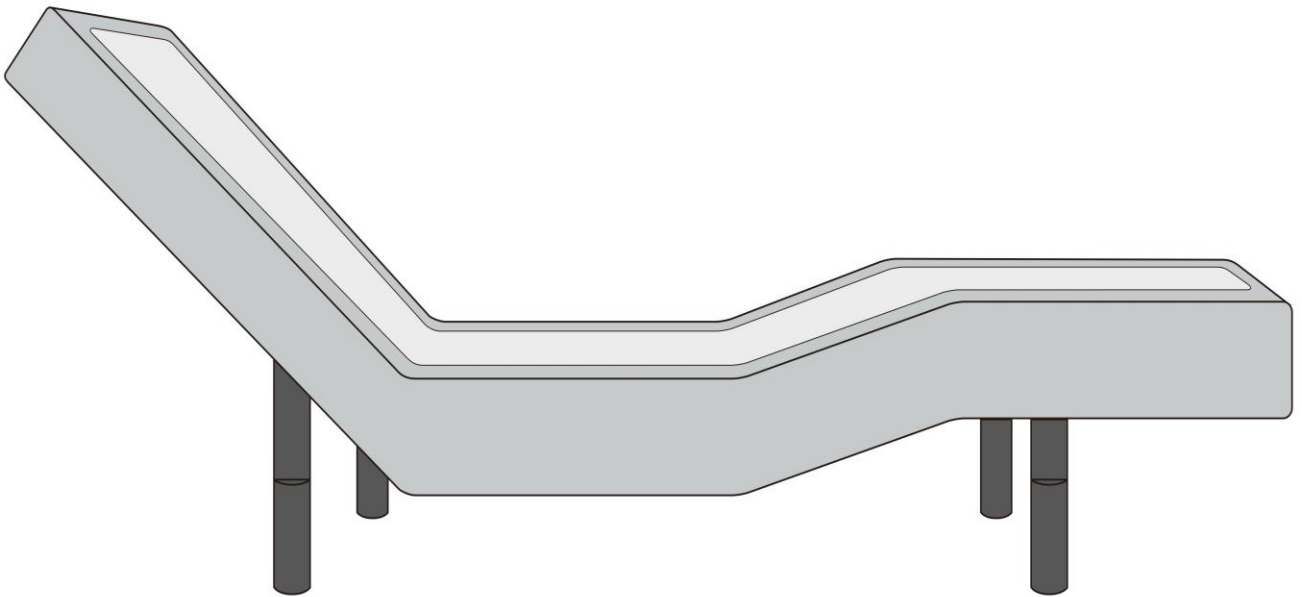

**Wireless Adjustable Base**

**Assembly and Operation  
Manual**

## Specifications

|  |                                     |                             |             |
|--|-------------------------------------|-----------------------------|-------------|
| Weight Capacity                        | 880 lb                              | Height                      | 14.5 inches |
| Incline Degree                         | Backrest: 0°~65°<br>Legrest: 0°~35° | Wall Hugger                 | X           |
| Power Input                            | AC 100-240 50/60 HZ                 | Power Transformer<br>Output | DC 29V 1.8A |
| Radio Frequency                        | 2.4MHZ                              | Massage Vibrator            | ✓           |
| USB Charger                            | X                                   | Bluetooth Control           | X           |
| Floor Light                            | ✓                                   | Flash Light on<br>Remote    | ✓           |
| Preset Position: ZG<br>and QUIET SLEEP | ✓                                   | Memory Position             | ✓           |

## Table of Contents

|   |    |
|---|----|
| Safety Precaution and Usage Guide.....          | 2  |
| To decrease the risk of electronic shock.....   | 2  |
| Adjustable base performance.....                | 3  |
| Restrictions of your adjustable base.....       | 3  |
| Electronic system information.....              | 4  |
| Parts List.....                                 | 7  |
| Electronics Overview .....                      | 8  |
| Assembly Guide.....                             | 9  |
| Operating Your Adjustable Base .....            | 13 |
| Wireless pairing operation.....                 | 17 |
| Power outage or failure of remote control ..... | 18 |
| Troubleshooting.....                            | 19 |
| <b>20 YEAR LIMITED WARRANTY</b>                 |    |

# Safety Precaution and Usage Guide

## Attention: SAVE THESE PRECAUTIONS AND USAGE GUIDES

Your new adjustable base has been strictly tested and inspected prior to dispatch. It is highly recommended to read these instructions thoroughly before you try your new adjustable base, in order to keep your high-quality adjustable base performing well in its lifetime but also to reduce the risk of fire, electric shock, burns or any injury to users.

### To decrease the risk of electronic shock, burns, or injury to users, children or pets, please follow these instructions.

1. After unpacking your adjustable, be aware of your **small children and pets**. Its packing material may put your **small children** or **pets** in **smothering dangers**.
2. **Unplug** the power cord from the power outlet **before installing** parts or **cleaning** your adjustable base.
3. **Keep** the power cord **away** from **water** and **heated areas**. If your adjustable base is **wet** or has a **frayed power cord**, please do not operate it.
4. **Do not** operate your adjustable base near **explosive gases** or **aerosol spray products** are being used.
5. **Never** operate your adjustable base when the **air openings** on its the electronic system are **blocked**.
6. **Never** drop or insert any object into **any air opening** on the electronic system of your adjustable base.
7. Before you **disconnect** the power cable, please return your adjustable base to the **flat position** and **stop all operations**.
8. **Unplug** your electronic gadgets from the USB port (option) of your adjustable base if they are **fully charged**.
9. **Do not** use the massage vibrators (option) on your adjustable, if you are a consumer with **artificial cardiac pacemakers**, before you **consult your physician**. Your pacemakers and massage vibrators may or may not be mutually affected by each other.
10. **Do not** use your adjustable base **in outdoors**. Your adjustable base is only designed for **in-home use**.
11. **Do not** operate your adjustable base if **small children** or **pets** are under your adjustable base. **Supervision** is required for operating your adjustable base if small children or pets are around your adjustable base. **Small children** are **not allowed** to operate your adjustable base without **parents** or **adult supervision**.
12. **Do not** use your adjustable base as a **hospital bed** or **care bed**. This adjustable base does not comply with **medical standards**. Your adjustable base is only designed for **residential purpose**.
13. **Adjust** your installed **headboard** (not included) against a **wall** to prevent from collapsing on persons, children or pets.
14. Use your adjustable base in compliance with the **restrictions** written on the Page 3.

## To keep your high-quality adjustable base performing well in its lifetime, please follow these instructions.

1. Your adjustable base is only designed for **In-Home Use**. This adjustable base is not designed for **outdoor** or **commercial** purpose.
2. **Do not** unscrew or open the **control box, lift motors, massage vibrators** (option), **SMPS, wired handset** or **remote control** (option), and **other electronic components** on your adjustable base, except for opening the battery compartment on your remote control or SMPS. The warranty will be void if there is any component damaged by users. Only **authorized service personnel** are allowed to repair or replace parts.
3. **Do not** mix **different** types of **batteries** or old batteries with a fresh one for your handset or SMPS.
4. **Remove** the **batteries** from your **remote control** (option) and **SMPS** if your adjustable base will not be used for a long time period to prevent damage caused by **battery leakage**.
5. **Do not** sit on the **head** or **leg section** while in the raised position. It can damage your adjustable base and lead to shorter life expectancy.
6. **Do not** lift or move the base **during operation**. It might cause damage to your system.
7. **Do not** sit or **step** onto the **wood lower frame (option) furnished with fabric beneath the mattress platform** while in the raised position. It can damage the frame.
8. **Do not** lift or move your adjustable base by **grabbing** its **mattress platform** or its **wood lower frame (option) furnished with fabric**. If it is necessary to lift or move your adjustable base, please do it by **grabbing the cross bars** of its metal frame.
9. Your adjustable base must be on **flat ground** to avoid damage to your product.
10. Use a **compatible mattress** for your adjustable base. A **memory foam mattress** or **latex mattress** is recommended. Some spring mattresses or pocket spring mattresses, for example, may not suit your adjustable base. Consult your mattress specialist to verify your mattress is compatible.
11. Use your adjustable base in compliance with the **restrictions** written on the Page 3.

## Restrictions of your adjustable base

1. Do not operate lift motors above the **10% duty cycle**. For example, after continuous 2-minute operation 18-minute rest is required.
2. Do not continuously or intensively operate the massage vibrators (option) above maximum 2 hours within 6 hours.
3. **Weight Restrictions:** the maximum weight limits on your adjustable base for Twin, Twin XL, Full and Queen are at a maximum of **400kg/880lbs** (evenly allocated across the mattress platform). This capacity includes the mattress and occupants. The warranty of your adjustable base will be void if excessive weight of 400kg / 880lbs is loaded on your adjustable base.

## Electronic system information

### Radio Frequency Compliance:

Radio Frequency: 2.4 MHZ.

FCC ID: PCU-JLDK-18-4

Your Device complies with part 15 of the FCC Rules. Operation is subject to the following two conditions:

1. This device may not cause harmful interference.
2. This device must accept any interference received, including interference that may cause undesired operation.

### Attention:

In compliance with FCC RF exposure requirements, there must be no change to the antenna or the device without permission. Users may be deprived of his/her right to the device if the device exceeds the RF exposure requirements caused by any change the antenna.

### Power Ratings:

Input: AC100-240V 50/60Hz 1.5A

Output: DC29V 1.8A

Protection Class: Class II

## IMPORTANT SAFETY INSTRUCTIONS

When using an electrical appliance, basic precautions should always be followed, including the following:

Read all instructions before using the Appliance.

**DANGER** - To reduce the risk of electric shock:

Always unplug this appliance from the electrical outlet immediately after using and before cleaning.

**WARNING** – To reduce the risk of burns, fire, electric shock, or injury to persons:

1. An appliance should never be left unattended when plugged in.  
Unplug from outlet when not in use, and before putting on or taking off parts.
2. Close supervision is necessary when this appliance is used by, on, or near children, invalids, or disabled persons.
3. Use this appliance only for its intended use as described in this manual.  
Do not use any attachment not recommended by the manufacture.
4. Never operate this appliance if it has a damaged cord or plug, if it is not working properly, if it has been dropped or damaged, or dropped into water.  
Return the appliance to a service center for examination and repair.
5. Do not carry this appliance by supply cord or use cord as a handle.
6. Keep the cord away from heated surfaces.
7. Never drop or insert any object into any opening.
8. Do not use outdoors.
9. Do not operate where aerosol (spray) products are being used or where oxygen is being administered.
10. To disconnect turn all controls to the off position, than remove plug from outlet.
11. The appliance is intended for household use.

## SAVE THESE INSTRUCTIONS

### SERVICING OF DOUBLE-INSULATED PRODUCTS

In a double-insulated product, two systems of insulation are provided instead of grounding. No grounding means is provided on a double-insulated product, nor is a means for grounding to be added to the product. Servicing a double-insulated product requires extreme care and knowledge of the system, and is to be done only by qualified service personnel.

Replacement parts for a double-insulated product must be identical to the parts they replace. A double-insulated product is marked with the words "DOUBLE INSULATION" or "DOUBLE INSULATED." The symbol (square within a square) is also able to be marked on the product --

- 

## INDICATIONS IMPORTANTES DE SÉCURITÉ

Lorsque vous utilisez un appareil électrique, quelques précautions de base sont à respecter, y compris :

Lire toutes les indications avant d'utiliser l'appareil.

**DANGER** – Pour réduire les risques d'électrocution :

Toujours débrancher cet appareil après l'avoir utilisé et avant de le nettoyer.

**AVERTISSEMENT** – Pour éviter les risques de brûlure, de feu, d'électrocution ou d'autres blessures physiques.

1. L'appareil ne doit jamais être laissé brancher sans surveillance. Débranchez-le lorsque vous ne l'utilisez pas, et avant d'attacher ou détacher des pièces
2. Lorsque l'appareil est utilisé près ou par des enfants, des invalides ou des infirmes, il faut absolument rester vigilant.
3. Utiliser cet appareil seulement dans le but d'accomplir les travaux décrits dans ce mode d'emploi.
4. Ne pas utiliser cet appareil, si les câbles ou les prises sont abîmés, s'il ne fonctionne pas sans problème, s'il est tombée ou endommagée ou s'il est tombé dans l'eau. Apporter votre appareil pour réparation ou vérification auprès de l'agent le plus proche ou le spécialiste correspondant.
5. Ne jamais porter cet appareil par son câble d'alimentation ou utiliser son câble comme poigné.
6. Éloigner cet appareil des surfaces surchauffées.
7. Ne pas introduire d'objets dans les ouvertures de l'appareil.
8. Ne pas utiliser cet appareil en plein air.
9. Ne pas utiliser l'appareil dans un endroit où l'on utilise des produits avec gaz propulseur (spray) ou de l'oxygène
10. Pour débrancher, vous devez éteindre tous les contrôles d'abord, puis débranchez la prise.
11. Cet appareil est pour un usage domestique.

## CONSERVER CES INSTRUCTIONS ENTRETIEN DES PRODUITS À DOUBLE ISOLATION











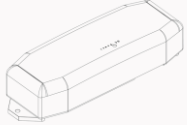

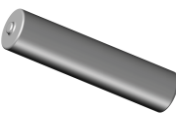
Un produit à double isolation est équipé de deux isolations au lieu d'une mise à la terre. La mise à la terre n'est pas vue sur un produit à double isolation et ne devrait donc pas être employé. L'entretien d'un produit à double isolation exigeant de grands soins et des connaissances poussées sur le système, il doit donc être réalisé seulement par du personnel qualifié. N'employer que des pièces de rechange originales pour l'entretien et la réparation. Un produit à double isolation est désigné de la manière suivante : « Isolation double » ou « A double isolement ». Le symbole (un carré dans un autre carré) peut également caractériser un tel produit.

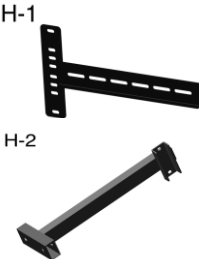

## Parts List

**IMPORTANT NOTE:**

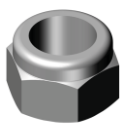
Check and confirm the following items are included in the carton,  
BEFORE disposing of any packing materials.

|   |  |   |  |
|---|--|---|--|
|    | A.<br>Remote Control * 1                             |    | B.<br>SMPS * 1<br>(Switched-Mode Power Supply)               |
|     | C.<br>AC Main Cable * 1                              |    | D.<br>DC Extension Cable * 1                                 |
|    | E.<br>AAA Battery * 3                                |    | F.<br>Support Leg * 4  |
|  | G.<br>Mattress Retainer * 1                          |  | H.<br>Headboard Brackets * 2 sets                            |
|  | I.<br>Hex Key * 1                                    |  | J.<br>Wrench * 1   |
|  | K.<br>Bolts for Retainer * 4<br>(on adjustable base) |  | L.<br>Ellipse Plate for Retainer * 2<br>(on adjustable base) |
|  | M.<br>Bolts for Headboard * 8                        |  | N.<br>Nuts for Headboard * 8                                 |
|  | O.<br>Washers * 16                                   |  | P.<br>Synch Cable * 1 (TXL ONLY)                             |

# Electronics Overview

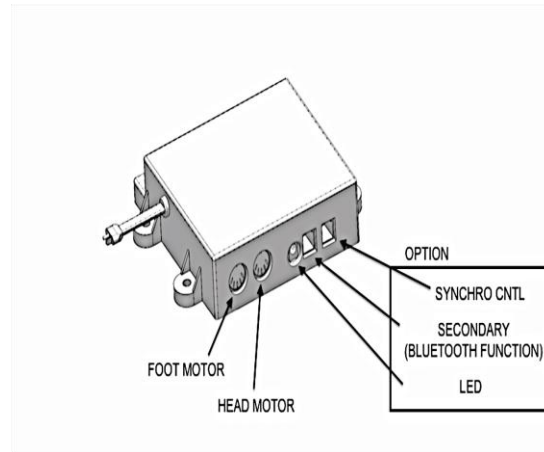
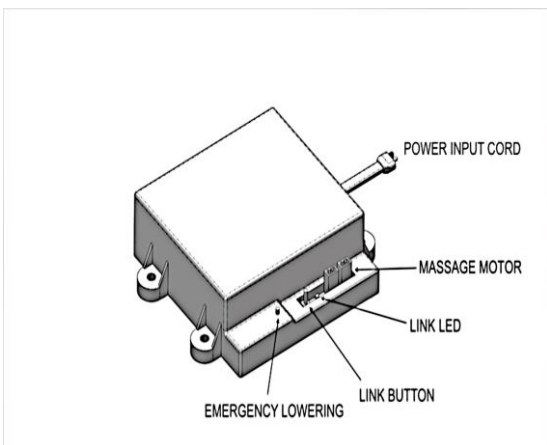
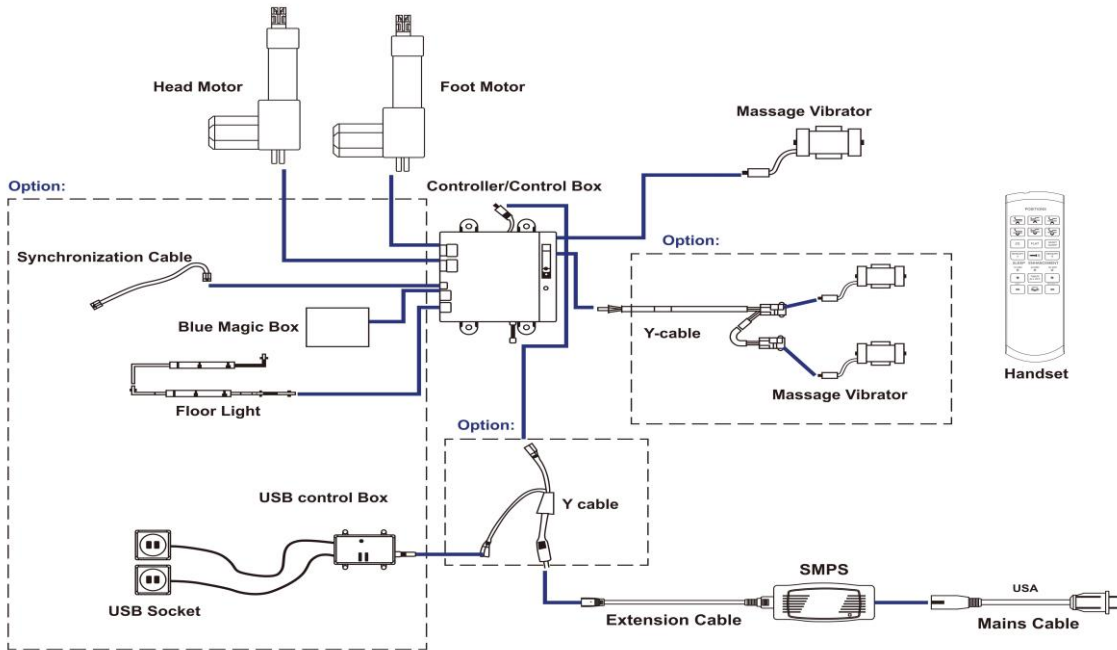

# Assembly Guide

## IMPORTANT NOTE:

Two people are required to set up your adjustable base.

### STEP 1



Leave the carton in the flat position. After opening this carton, carefully take your Adjustable Base to the desired location and leave it topside down.

### STEP 2

Take out four Support Legs (F) from the Accessories Box. Tighten the Four Legs onto the Adjustable Base. Securely tighten the legs and leave no gap between the legs and the base.

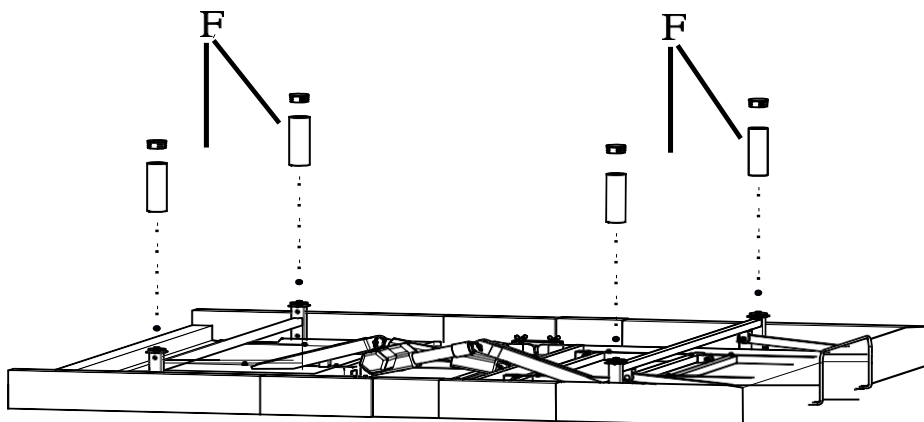

### STEP 3

Insert three AAA Batteries (E) into the compartment of the Remote Control (A).

## STEP 4

Insert the AC Main Cable (C) into the SMPS (B).

Insert the male end of the DC Extension Cable (D) to the SMPS (B).

Connect the female end of the DC Extension Cable (D) to the male end of the Y-Cable connected to the Control Box and the USB Control Box.

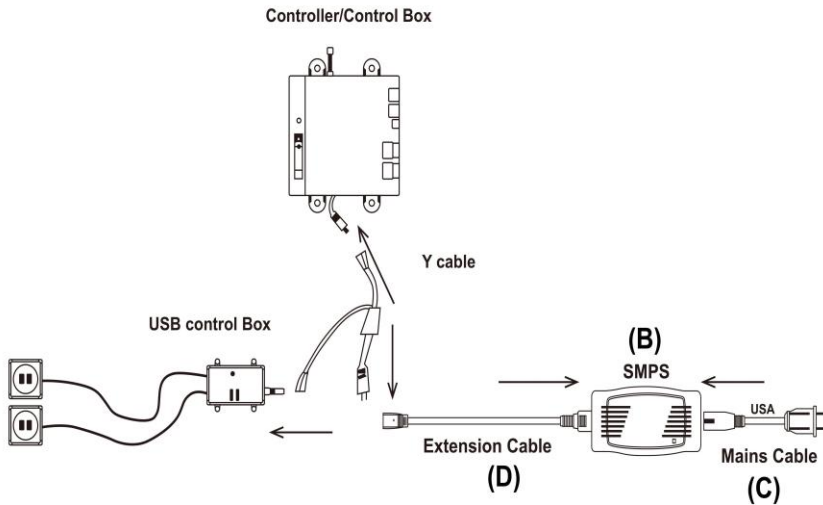

## STEP 5: SYNCHRONIZATION (OPTION)

Synchronization may be required for setting up two TXL Bases.

Insert one end of the Synch Cable (P) into the Control Box of your Adjustable Base. After completing the first five steps on the Second Base, insert the other end of the Synch Cable (P) into the Control Box of the second TXL Adjustable Base.

## STEP 6

Carefully flip over your topside-down Adjustable Base. Lift up the Base to desired location.

### IMPORTANT NOTE:

Be Careful when flipping your Base:

The installed legs could get damaged or bent by excessive pressure, if you lean your Adjustable Base on the legs.

1. Do not recline the Base against the installed legs to flip it over.
2. Do not drag the Base across the floor.

## STEP 7

Plug the AC Main Cable (C) in an electrical outlet with 100-240V, 50/60 Hz. A surge protector (not included) is recommended for longer life of your Adjustable Base.

## STEP 8

Take out Retainer (G) Hex Key (I) and remove 4 Bolts For Retainer (G) and 2 Ellipse Plates (L) from your adjustable base.

Follow the installation instruction in the following picture.

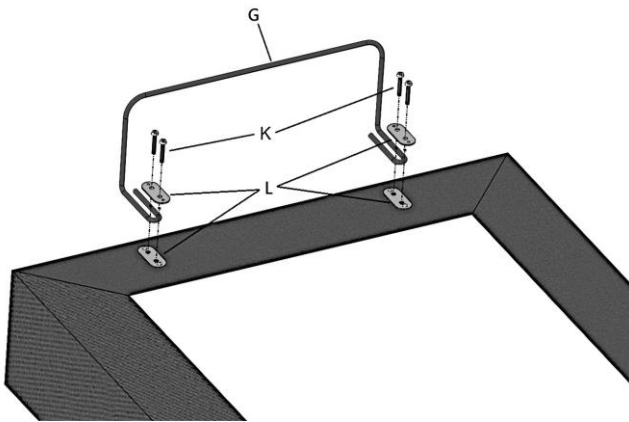

## STEP 9 (Installing Headboard)

Raise the Backrest by using Remote Control (A). Take out the Wrench (J), two Bolts (M), four Washers (O) and two Nuts (N) from the Accessories Box.

Refer to the following picture. Place the Headboard Bracket (H-2) on the vertical tube of the right hand side of your Adjustable Base. Insert the Bolt (M) with the Washer (O) through the pre-drilled holes on the Bracket (H-2) and the vertical tube on your Adjustable Base. Fasten the Bolt (M) with the Washer (O) and the Nut (N) with the Washer (O) by using the Wrench (J)

Redo this step on the left hand side of your Adjustable Base.

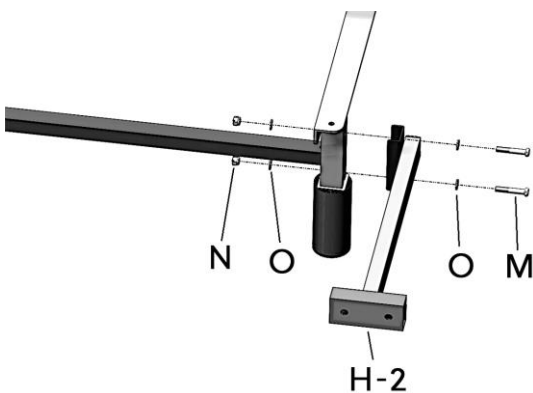

## STEP 10 (Installing Headboard)

The Bracket (H-1) allows adjustment to meet the dimension of user's Headboard. After choosing desired pre-drilled holes on the Bracket (H-1), pass the Bolts (M) with the Washer (O) through the holes on H-1 and H-2 Brackets. Fasten these Bolts (M), Washers (O) and Nuts (N) by using the Wrench (J).

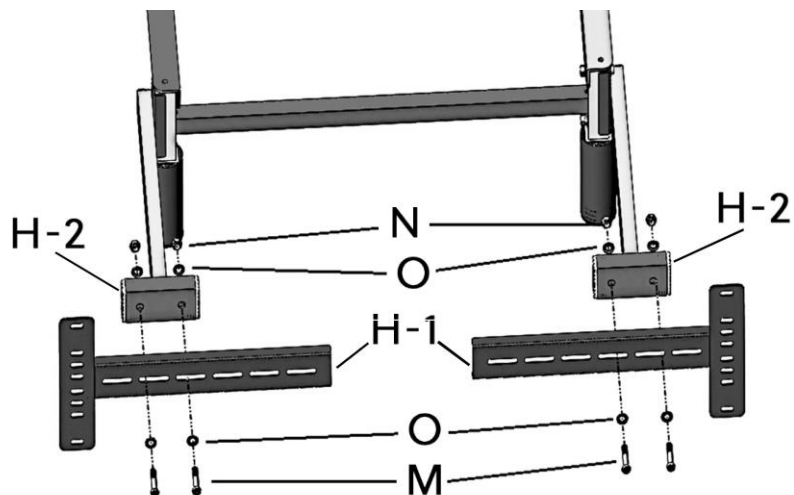

## Step 11

Now place your mattress on your Adjustable Base. All the installation procedures have been completed.

# Operating Your Adjustable Base

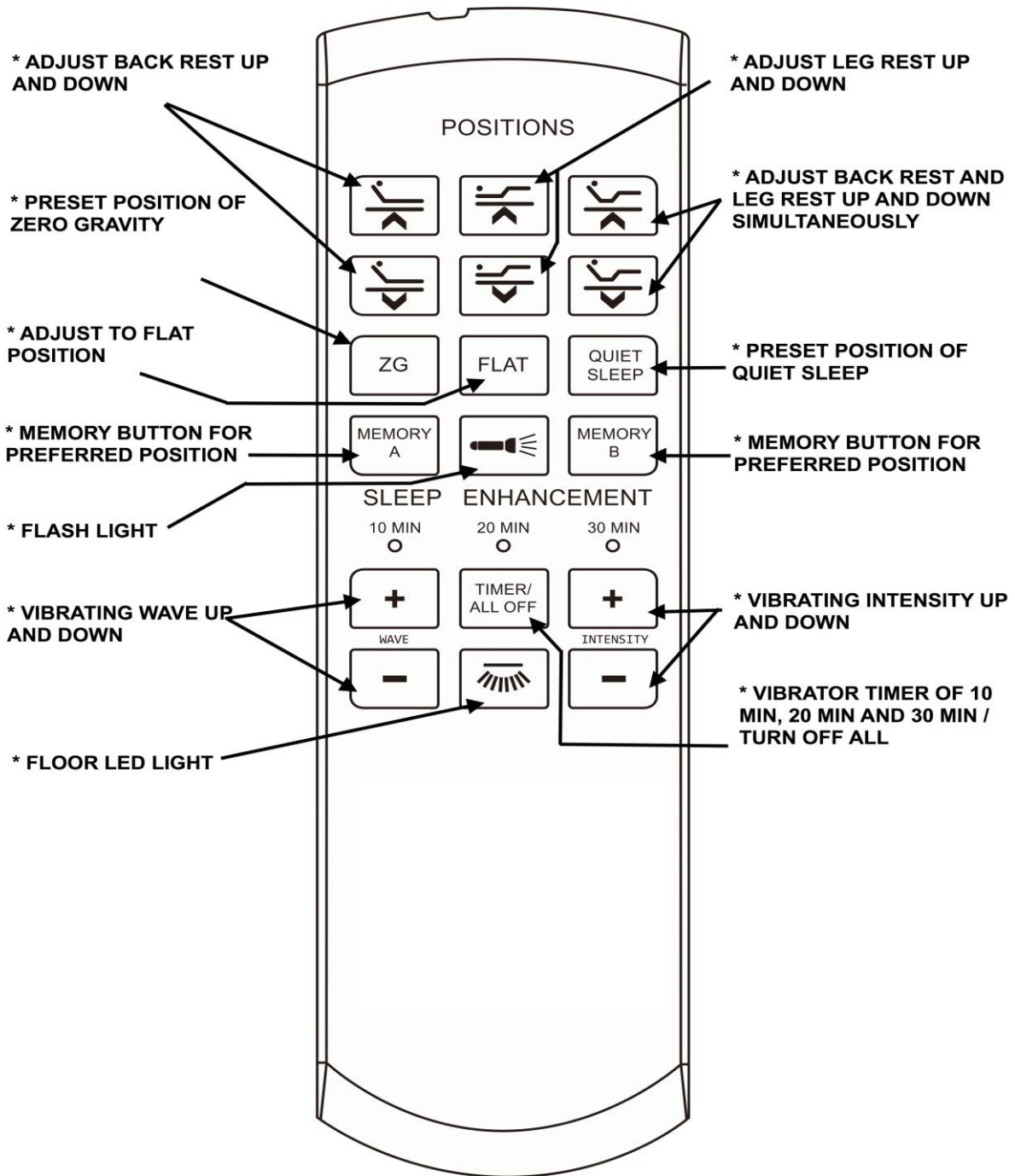

A.



Press and hold the button to RAISE BACK REST. Stops when released.

B.



Press and hold the button to LOWER BACK REST. Stops when released.

C.



Press and hold the button to RAISE LEG REST. Stops when released.

D.



Press and hold the button to LOWER LEG REST. Stops when released.

E.



Press and hold the button to RAISE BACK REST and LEG REST SIMULTANEOUSLY. Stops when released.

F.



Press and hold the button to LOWER BACK REST and LEG REST SIMULTANEOUSLY. Stops when released.

G.

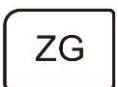

Click the button to automatically adjust user's bed to zero gravity position. Stops by clicking any button.

H.



Click the button to automatically adjust user's bed to QUIET SLEEP position. Stops by clicking any button.

I.



Click the button to automatically adjust user's bed to FLAT position. Stops by clicking any button.

J.



Click the button to automatically adjust user's bed to the Memory A position preset by user. Stops by clicking any button.

K.

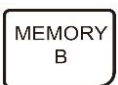





Click the button to automatically adjust user's bed to the Memory B position preset by user. Stops by clicking any button.







## Preset Memory Position

Step 1: Click  to flatten the bed.

Step 2: Adjust the Head and Foot position to a desired position by pressing , , , or .

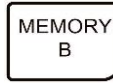
Step 3: Press and hold  for 3 seconds until backlight starts flashing

Step 4: Release  and then click one of  or  before LED stops flashing. Then the flashing stops immediately to indicate the memory learning has been completed successfully.

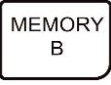
Step 5: To default  or , press and hold one of them for approximate six seconds until backlight stops flashing from first flashing.

L.



Click the button to turn on the FLASHLIGHT on the remote control or push to turn it off. The FLASHLIGHT will stay on as long as the button is pressed. After releasing the button, the FLASHLIGHT will stay on for several seconds then turn off simultaneously when the backlight turns off.

M.



Click the button to turn on the FLOOR LED LIGHT or push to turn it off. FLOOR LED LIGHT will stay on for five minutes if the button is not clicked again.

N.



Click the button to activate the vibrators and increase the vibrating INTENSITY. There are three levels of INTENSITY.

O.

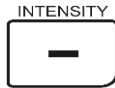

Click the button to activate the vibrators and decrease the vibrating INTENSITY. There are three levels of INTENSITY.

P.

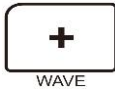

Click the button to activate the vibrators and increase the vibrating WAVE. There are four levels of WAVE.

Q.

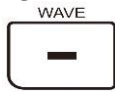

Click the button to activate the vibrators and decrease the vibrating WAVE. There are four levels of WAVE.

The “WAVE” essentially represents the vibrating mode. In WAVE mode from level 1 to level 3 all massage motors vibrate at intervals and at level 4 massage motors vibrate continuously.

The intervals and the corresponding level are below:

| Level | Time for Vibrating On | Time for Vibrating Off |
|-------|-----------------------|------------------------|
| 1     | 500mS                 | 500mS                  |
| 2     | 350mS                 | 350mS                  |
| 3     | 200mS                 | 200mS                  |
| 4     | Continuous            |                        |

R.



Click the button to STOP ALL MOVES, including the actuators and massage vibrators, and change the vibrator TIMER

The timer has 3 levels of 10 minutes, 20 minutes and 30 minutes. The Massage Vibrators will not run for any of these time periods unless any related massage button is clicked.

The LED indicates the corresponding time period

| Time       | Sign        | LED Indicator  |
|------------|-------------|--|
| 10 minutes | 10 MIN<br>○ | Flashing a time means the vibrating time is 10 minutes |
| 20 minutes | 20 MIN<br>○ | Flashing a time means the vibrating time is 20 minutes |
| 30 minutes | 30 MIN<br>○ | Flashing a time means the vibrating time is 30 minutes |

## Wireless pairing operation

### Step1:

Open the battery compartment on the Remote Control. Remove the yellow sticker, which covers DIP Switch. Push the DIP Switch on the Remote Control to a certain position (different from the position on the other Remote Control paired with it near both Control Boxes.) and put three AAA batteries into the Remote Control.

### Step2:

Connect the Control Box to the SMPS. Plug its AC Main Cable to the Power Outlet.

### Step3:

Press and hold the LINK BUTTON on the Control Box until the LINK LED on the Control Box turns off. Then release the Link Button and the LINK LED turns flashing. That indicates the Control Box is pending to be paired.

### Step4:

Press and hold simultaneously the button  and the button  on the Remote Control until backlight turns flashing. Release the two buttons and the backlight LED continue flashing and search the pending Control Box where the LINK LED is flashing.

Once both the backlight on the remote control and the LINK LED on the control box stop flashing, the pairing operation is completed.

Please repeat the all above steps if the pairing operation failed.

#### Important Notes:

1.

It is strongly recommended, if multiple Bases are being used in the same house or area, each Base should be configured differently. Each Control Box must be paired with the different Remote Control where the DIP-Switch position is different. Do not pair both Controller with the same Remote Control or movement could occur on additional Base unexpectedly.

2.

It is important if two Control Boxes (Split King) are expected to work synchronously, they must still be configured differently to pair with different Remote Controls with different DIP-Switch position. Do not pair both Control Boxes to work with the same Remote Control.

## Power outage or failure of remote control

In the case of failure of the Remote Control, press and hold the Emergency Button on the Control Box to flatten your Adjustable Base. When releasing the Emergency Button, all movement will stop immediately.

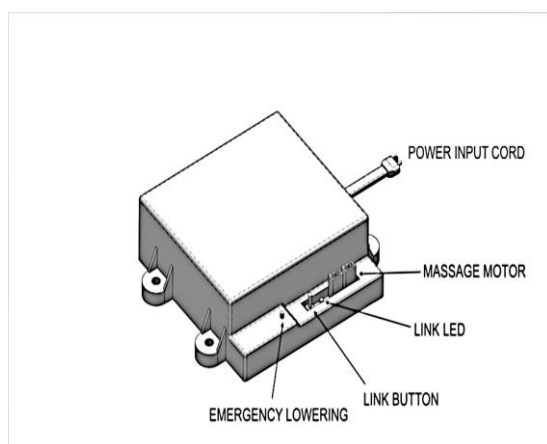

In the case of the power outage, insert two 9V Batteries (not included) to the Battery Compartment on the backside of SMPS. It can be used as the backup power. It is only for flattening the Base without load. Do not use the Massage Vibrators when using the backup power.

# Troubleshooting

| TROUBLE  | SOLUTION   |
|--|--|
| There is no feature of the base that can be activated. | <p>Remote control illuminates</p> <ul style="list-style-type: none"> <li>◆ Reset the electronic components by unplugging your base for 30 seconds. Re-plug it into the power outlet.</li> <li>◆ Ensure the surge protection or the power outlet is working. Test it by plugging in another working electronic appliance.</li> <li>◆ The unworked power outlet may be led by the tripped electrical circuit breaker. Check the box of electrical service breaker.</li> <li>◆ Re-pair the remote control (see Wireless pairing operation).</li> </ul> <p>Remote control does not illuminate</p> <ul style="list-style-type: none"> <li>◆ Replace batteries in the remote control.</li> <li>◆ Install 3 AAA batteries correctly.</li> </ul> |
| The base cannot return to the flat position.           | <ul style="list-style-type: none"> <li>◆ Ensure the base is not obstructed. Remove the obstruction.</li> <li>◆ Ensure there is a sufficient space between the wall or headboard and the edge of the mattress. The insufficient space may obstruct the movement of the base.</li> </ul>   |
| Excessive noise of massage function.                   | <ul style="list-style-type: none"> <li>◆ Place carpet pieces or soft material beneath each leg of the base.</li> <li>◆ If headboard is equipped ensure the hardware of the headboard brackets are tightened firmly.</li> <li>◆ Ensure the base stands clear of walls, nightstands or other objects.</li> </ul>   |
| Minor interference with lifts functions.               | <ul style="list-style-type: none"> <li>◆ Replace batteries in remote control if necessary.</li> <li>◆ Ensure you're operating within 10% duty cycle (see Restrictions of your adjustable base).</li> <li>◆ Press the adjust buttons squarely and accurately.</li> <li>◆ Control box may be subject to the common radio frequency from other devices. Reprogram the remote control and the control box on a different radio frequency if necessary (see Wireless pairing operation).</li> </ul>   |
| USB ports do not charge electronic gadgets.            | <ul style="list-style-type: none"> <li>◆ Try another well-working USB cable.</li> <li>◆ Unplug all USB cables for 10 minutes to reset and try it again.</li> </ul>   |





## 20 YEAR LIMITED WARRANTY

Your New Adjustable Base has a 20 Year Limited Warranty, subject to the terms and conditions set forth herein.

The Purchaser must show original proof of purchase for Warranty to be valid.

The decision for repair or replacement of defective parts under this limited warranty is the option and sole discretion of the manufacturer.

### **Year-1: Full Coverage of Parts and Labor**

The manufacturer against defects and workmanship warrants this adjustable base for a period of one year from the date of purchase.

During this time, the manufacturer will repair or replace, at no cost to the original purchaser, any warranted parts found to be defective by the manufacturer.

### **Year 2 – 3: Full Coverage of Parts Only**

During 2 through 3 years from the original purchase date, the manufacturer will offer the original purchaser replacement parts for any defective adjustable base parts determined by the manufacturer to be defective.

The manufacturer's liability is limited to the replacement of the defective electrical and mechanical parts only.

The original purchaser shall bear all transportation costs for parts and installation labor related to the delivery and replacement of the defective parts.

### **Year 4 – 20: Full Coverage of Mechanical Parts Replacement**

During 4 through 20 years, the manufacturer will offer the original purchaser mechanical replacement parts for any mechanical base part to be found defective. The original purchaser shall pay 1/16 of the current replacement parts multiplied by the number of years after the fourth year from the original purchase date.

The manufacturer's liability is limited to the replacement of the defective mechanical parts only. This does not apply to the fabrics, electrical components, lift motors, massage motors and wood components.

The purchaser shall bear all transportation costs for parts and installation labor related to the delivery and replacement of the defective part.

### **Additional Terms and Conditions:**

This warranty is void and does not apply:

- ◆ To any damage caused by user
- ◆ If damage occurred during transit or mishandling
- ◆ Subjected to physical or electrical abuse or misuse
- ◆ Exceeded the Load Capacity recommended by the manufacturer in your Owner's Manual

Repair or replacement of adjustable base parts will be the sole remedy of the purchaser. This warranty excludes the reimbursement for inconvenience and normal wear and tear. There shall be no liability on the part of the manufacturer and their respective parents, subsidiaries, divisions or affiliates for any special, indirect, incidental or consequential damages or other damages, claim or loss not expressly covered by terms of this Limited Warranty.

For further assistance, please contact the dealer you purchased your Adjustable Base from.